

Pivot Entry Doors

THERMA TRU[®]
DOORS

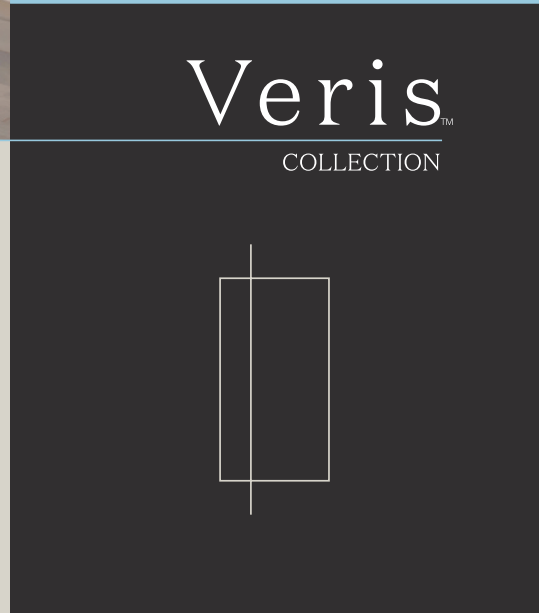

Modern style. Unique movement.

Experience the epitome of modern style with unique movement. Veris pivot entry doors connect to the door frame from a pivot point at the top and bottom of the door instead of along the edge. Their smooth operation, sleek style and expansive use of glass make them the perfect choice for any contemporary entryway.

Confidence in a Complete System

Create the ultimate open-air living experience with superior performance thanks to our full-system approach. With the Veris™ collection, each piece is engineered to work together seamlessly.

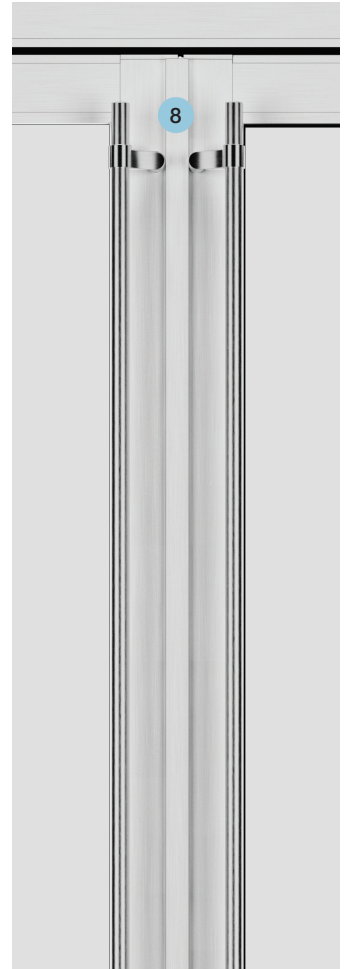

Shown from the exterior side of the door system.

*French door systems and 10' door systems will include flush bolts.

**Door systems built with a flush sill have little resistance to water penetration and have a potential to leak if installed exposed to weather. We recommend these systems be installed away from weather under large soffits or overhangs. For ADA compliance, the door must provide a minimum 32" clear opening width.

Component images shown from interior side of the door system.



A **door catch** holds the door open while blending into the system. A rubber stopper provides quiet operation.



In addition to the **deadbolt**, the **flush bolt*** offers another locking point and is integrated into single and french configurations for added security and enhanced performance in severe weather.

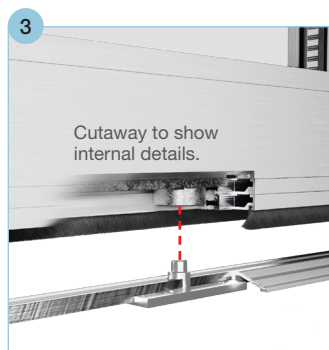
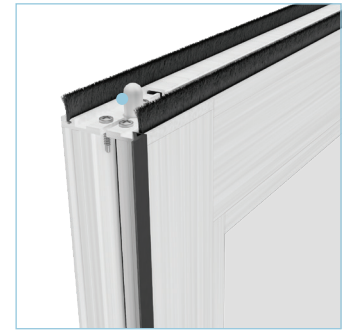

Pivot hardware delivers the innovative movement of the pivot door with a **sealed bearing** on the bottom for smooth, quiet operation.

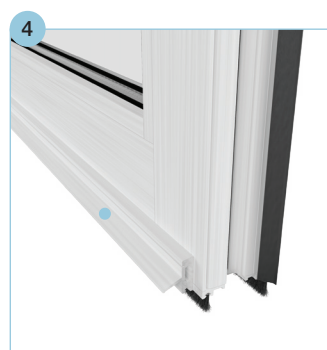
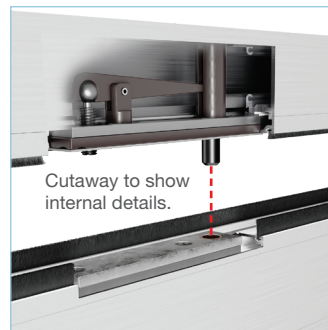

Built-in **rain deflector** helps protect areas exposed to wind-driven rain, enhancing weather protection.

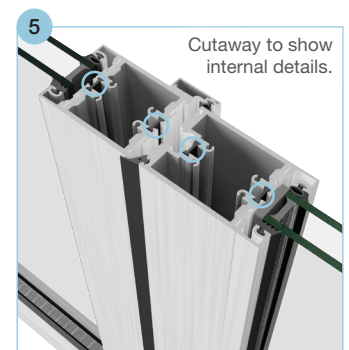

Thermal break design separates interior and exterior aluminum to reduce heat and cold transfer between indoors and outdoors which helps reduce condensation.

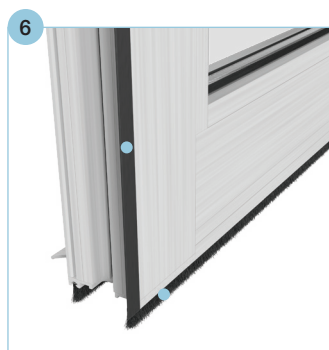

Designed to provide the best possible fit between panel and frame, the **weatherstrip** helps prevent water and air from entering the home.

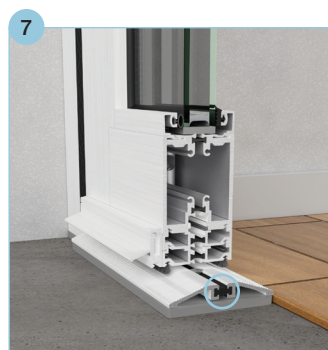

Thermally broken sills reduce the transfer of heat and cold through the door system for greater energy efficiency while reducing condensation buildup. Available in a flush configuration for ADA compliance.**



As part of french door configurations, an **astragal** is integrated into the unit to assist with sealing the door system for better protection from the elements.

V-2 vs. V-3



V-2 Systems: Built for everyday life.

Our V-2 systems are designed to meet the needs for most homes and structures. Featuring our standard components that are quality tested for long-term use, the V-2 system is perfect for residential dwellings in most areas of the United States.

Panel & System Thickness: 2-1/4"

Maximum Height: 8'



V-3 Systems: Performance where you need it.

Our V-3 systems are engineered to meet the high-performance needs of specific regions, building codes and commercial structures, and are built to support larger glass panels found in our taller units. With high-performance components that can stand up to heavy-duty use, the V-3 system is ideal for structures and door units that require extra support and stability.

Panel & System Thickness: 3"

Maximum Height: 10'

Size Offering

Pivot configurations with a door that exceeds 8'0" in height or a transom that exceeds 8'0" in width will be built as a V-3 system.

Doors		Single & French			
Panel Width		3'6"	4'0"	5'0"	6'0"
Height	6'8"				
	7'0"				
	8'0"				
	9'0"				
	10'0"				

Sidelites					
Width		14"	18"	20"	24"
Height	6'8"				
	7'0"				
	8'0"				
	9'0"				
	10'0"				

Transoms		Single & Single w/One Sidelite				Single w/Two Sidelites				French			French w/Two Sidelites		
Panel Width		3'6"	4'0"	5'0"	6'0"	3'6"	4'0"	5'0"	6'0"	3'6"	4'0"	5'0"	3'6"	4'0"	5'0"
Height	14"														
	18"														
	20"														
	24"														

- Standard Lead Time
- Extended Lead Time

Configurations

Shown from the exterior side of the door system.

Available as inswing or outswing.



Single

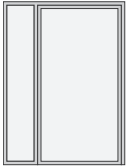

Single with
Left Sidelite

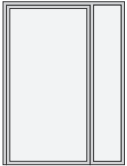

Single with
Right Sidelite

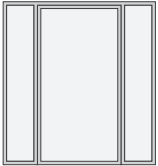

Single with
Two Sidelites



Single with
Transom

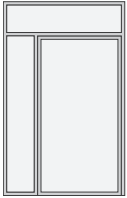

Single with
Left Sidelite
and Transom

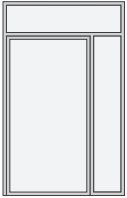

Single with
Right Sidelite
and Transom

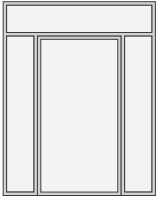

Single with
Two Sidelites
and Transom

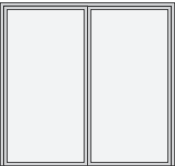

French

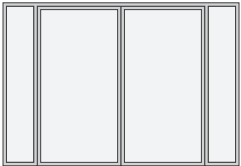

French with
Two Sidelites

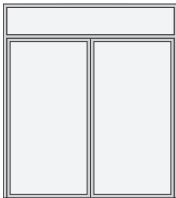

French with
Transom



French with
Two Sidelites and
Transoms



Glass Options



Enhanced Low-E

Blocks 95% of the sun's harmful UV rays, helping to preserve the color and materials of your interior furnishings, draperies and wall treatments.*



Low-E

Delivers exceptional energy efficiency, retaining heat in the winter and reflecting it in the summer.



Turtle with Low-E

Tinted gray to reduce interior light projection as required near sea turtle nesting areas. Includes Low-E coating for exceptional energy efficiency.

Optional Neat+™ Coating

All Low-E glass in the Veris collection is available with Neat+ coating. This low-maintenance coating is designed to help keep glass clear and free of watermarks, reducing the need for cleaning.*



Without
Neat+ Coating

With
Neat+ Coating



*For more information on enhanced Low-E glass and Neat+ coating, visit www.solarinnovations.com.

Divided Lites

Not available for 10' units.

Available Patterns

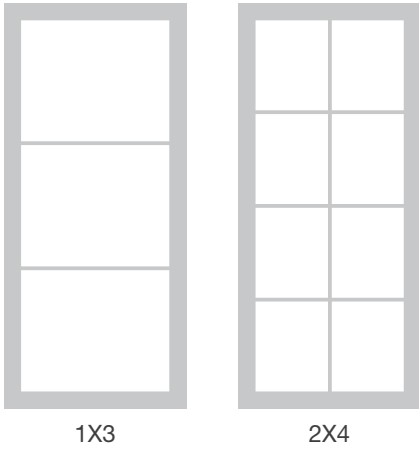

1X3

2X4

Grilles Between Glass (GBGs)



GBGs are sealed between two panes of tempered glass for a smooth easy-to-clean surface.

Height: 5/8"
Depth: 3/16"

Finish Options for GBGs



White

Black

Split finish not available for GBGs.

Simulated Divided Lites (SDLs) with Grilles Between Glass (GBGs)

SDLs are adhered to the interior and exterior panes of tempered glass and are finished to complement the door system. For a more authentic divided lite look, SDLs are layered over black GBGs.

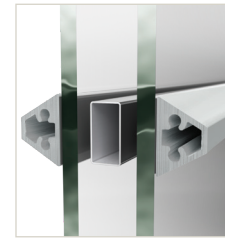

Traditional Profile

Height: 3/4"
Depth: 15/32"

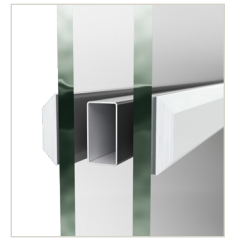

Flat Profile

Height: 3/4"
Depth: 5/32"

Configurations with SDL / GBG Patterns

1X3

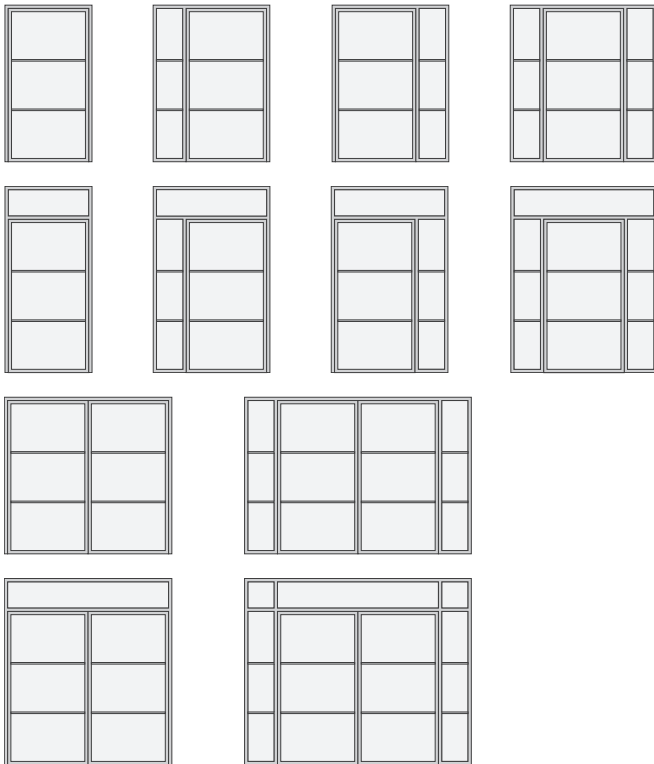

2X4

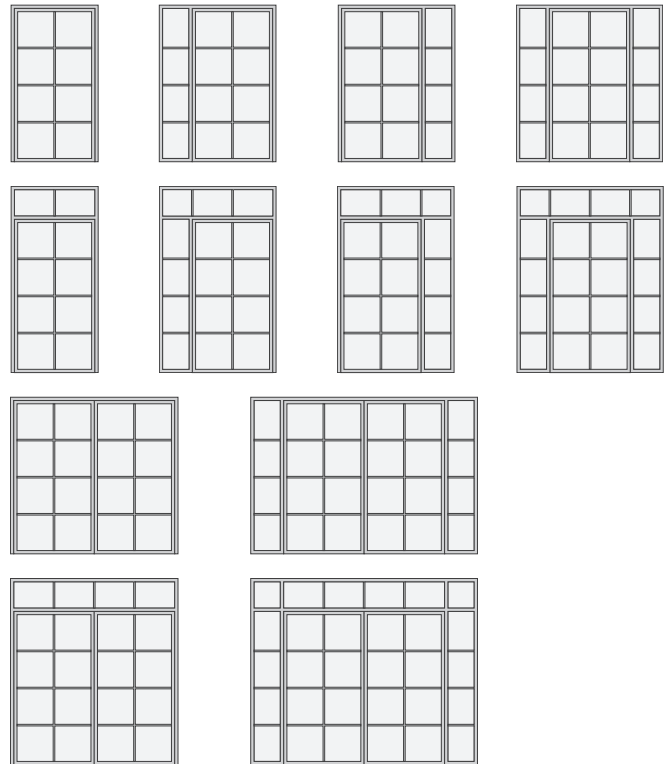

Finish

Choose from an on-trend assortment of finishes designed to complement most homes.

Standard Lead Powder Coated

Similar to semi-gloss finish.

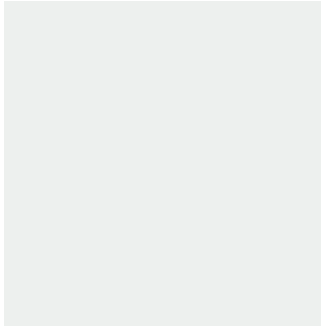

White

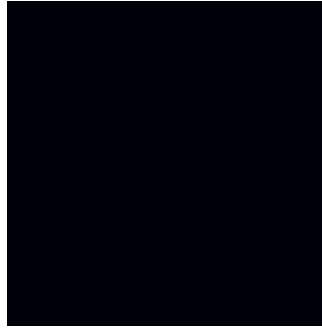

Black

Standard Lead Anodized

Similar to eggshell finish.



Clear

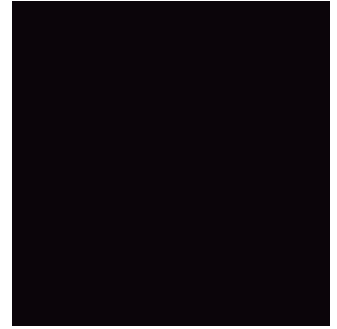

Dark Bronze

Extended Lead Powder Coated

Similar to semi-gloss finish.

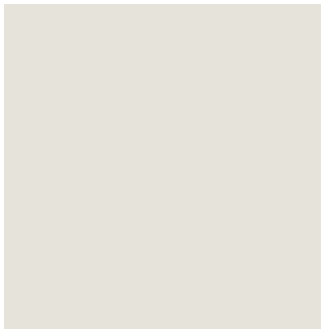

Bone White

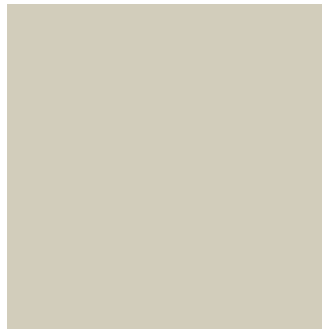

Sandstone



Fashion Gray



Charcoal



White / Black

Additional Split Finish Options

Choose any two colors to create a split finish that complements the interior and exterior of the home. Available on extended lead time.

Order 3-1/8" x 4" samples of finish colors at store.thermatru.com.

Sills



Flush Sill

Sill Finish Options

- Clear Anodized
- Dark Bronze Anodized

Note: Finish colors may vary from an actual application due to fluctuations in finishing or printing. See your Therma-Tru seller for details on the Veris collection limited finish warranty and exclusions. Door systems built with a flush sill have little resistance to water penetration and have a potential to leak if installed exposed to weather. We recommend these systems be installed away from weather under large soffits or overhangs.

Handlesets

Active handlesets come standard with thumbturn interior lock with keyed exterior.

The multi-point locking system engages the panel and frame at three points for enhanced security while helping to preserve the compression seal's hold, even under the pressure of high winds.

Inspira and Verge handlesets deliver the minimalist style of a modern door pull. The handles are partially offset from the rail for comfortable access to the lock. The lock features an interior thumbturn and exterior keyed options. French door systems and 10' door systems will also include flush bolts.

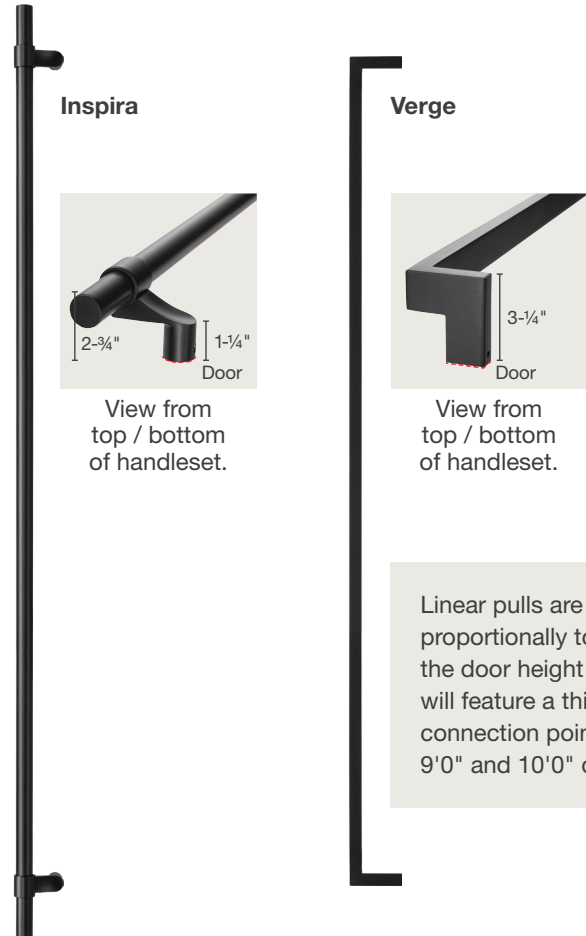

Handleset Finish Options



Availability

	Brass	Brushed Nickel	Black Nickel	Satin Nickel	Oil-Rubbed Bronze
Heirloom	Standard Lead Time	Standard Lead Time	Standard Lead Time	Standard Lead Time	Standard Lead Time
Venture	Standard Lead Time	Standard Lead Time	Standard Lead Time	Standard Lead Time	Standard Lead Time
Millennium	Standard Lead Time	Standard Lead Time	Standard Lead Time	Standard Lead Time	Standard Lead Time
Realm	Standard Lead Time	Standard Lead Time	Standard Lead Time	Standard Lead Time	Standard Lead Time
Inspira	Extended Lead Time	Standard Lead Time	Standard Lead Time	Extended Lead Time	Extended Lead Time
Verge	Extended Lead Time	Standard Lead Time	Standard Lead Time	Extended Lead Time	Extended Lead Time

Standard Lead Time
 Extended Lead Time
 Not Available

V-2 Details

 **Thermal Break** Veris glass door systems feature thermal breaks, shown here in red.

Sill

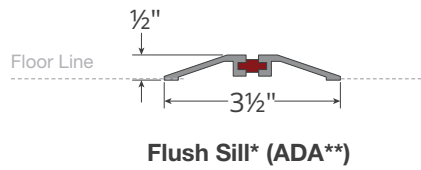

Vertical & Horizontal Rail

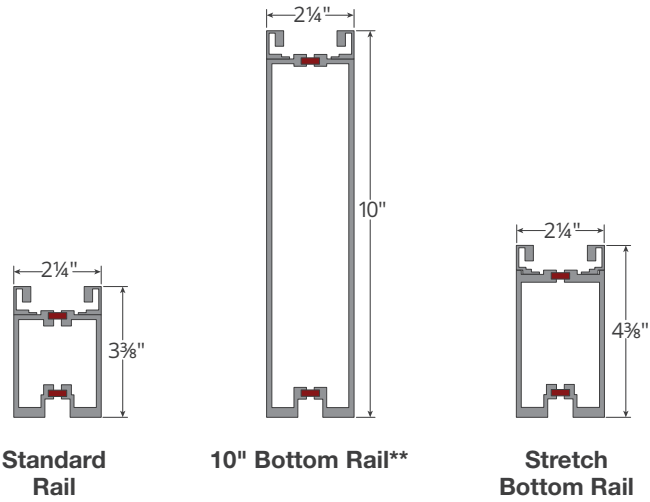

*Door systems built with a flush sill have little resistance to water penetration and have a potential to leak if installed exposed to weather. We recommend these systems be installed away from weather under large soffits or overhangs.

**For ADA compliance, the door must provide a minimum 32" clear opening width. Verify all other ADA compliance requirements with your local building code official.



V-3 Details

Sill

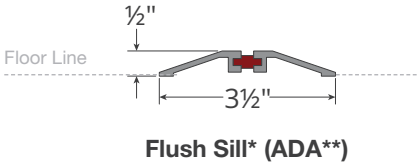

Vertical & Horizontal Rails

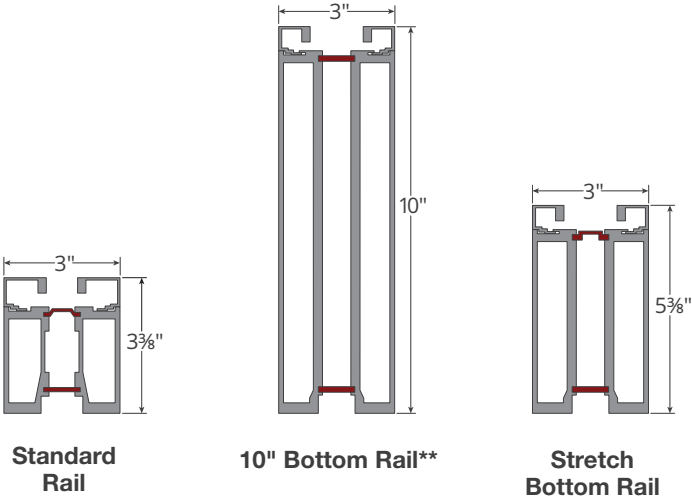

Scan to learn more.

THERMA TRU
DOORS



About the Veris™ Collection

Therma-Tru's Veris collection is manufactured by Solar Innovations – a recently acquired brand of Therma-Tru. Solar Innovations brings more than 20 years of open-air living product innovations, including these high-performing door systems. Featuring expansive glass, these door systems are ideal for contemporary front entries and connecting indoor and outdoor spaces around the home.

Lifetime Durability & Performance

Designed for easy, worry-free operation, we're so confident in our fully engineered systems that we back them with a 1x transferable lifetime limited warranty for peace of mind. In addition, the finish is covered by a balance-transferable 10-year limited warranty.

Visit VerisCollection.com for details on limited warranties and exclusions.

LIFETIME
LIMITED
WARRANTY
TRANSFERABLE

10YEAR
LIMITED
WARRANTY
TRANSFERABLE



THERMA-TRU
DOORS

Where Home Begins™

thermatru.com

1-800-THERMA-TRU (843-7628)

1750 Indian Wood Circle
Maumee, OH 43537



#thermatru

©2023 Therma-Tru Corp. All rights reserved. All trademarks and images featured are owned by their respective company and used with permission. Registered trademarks are registered in the U.S. and may be registered internationally. Therma-Tru Corp. and Solar Innovations LLC are part of Fortune Brands Innovations, Inc. – an industry-leading home and security products company. Neat+ is a trademark of Cardinal Glass Industries Inc. and is used here with permission.

Part #MAFVRSPDS23 MTZT / JAN 2023



Scan to learn more.